

Tilt LCD/PLASMA wall Mount

assembly instructions



















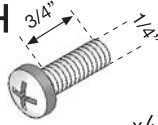

CAUTION - This Plasma/LCD mount is intended for use only with the maximum weight indicated. In the event of products being heavier than the maximum weight indicated this may result in product instability that could cause possible injury.

For further information, visit us at:
www.barkanmounts.com

Model	Elegant Audio Video Self	Elegant Cable Cover
41	80	83

Max PLASMA / LCD
60"/152cm

Max	US	EU
	143lbs	65kg

1:10	A		x2	B		x2	C		D		x1
	1:2	E		x1	F		x6	G		H	
I			x2	J		x4	K		M		The provided Screen bolts may change in size according to changing screen requirements
L			x1	N		x6	O		P		x4
Q			x2	R		x2	S		T		x2



Please make sure that package contains all parts

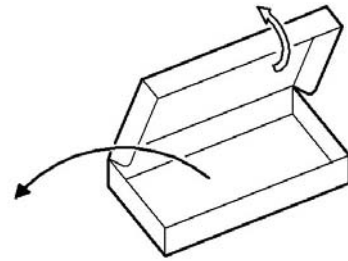

1 Hardware assembly

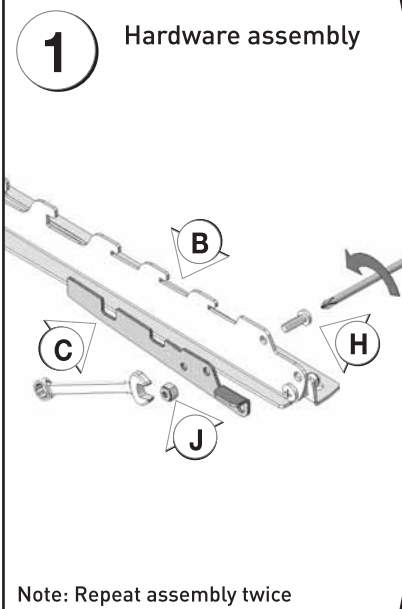

Note: Repeat assembly twice

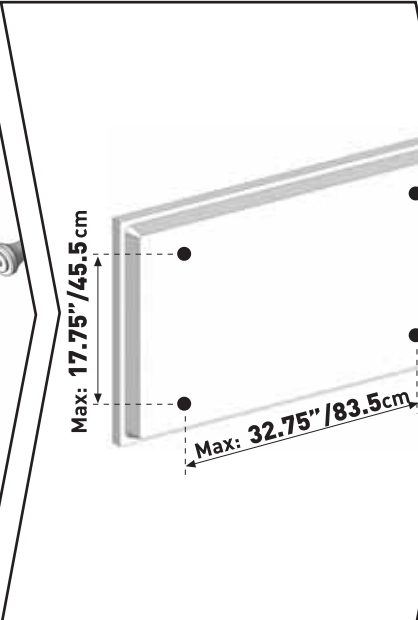

Hardware assembly to screen

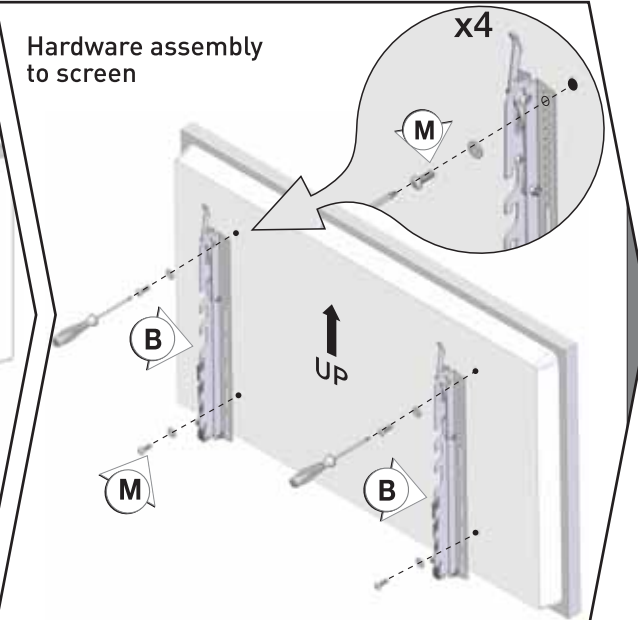

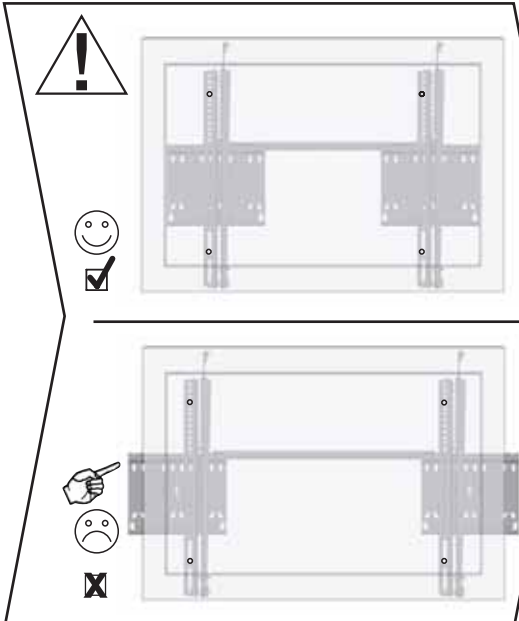

Width adjustment

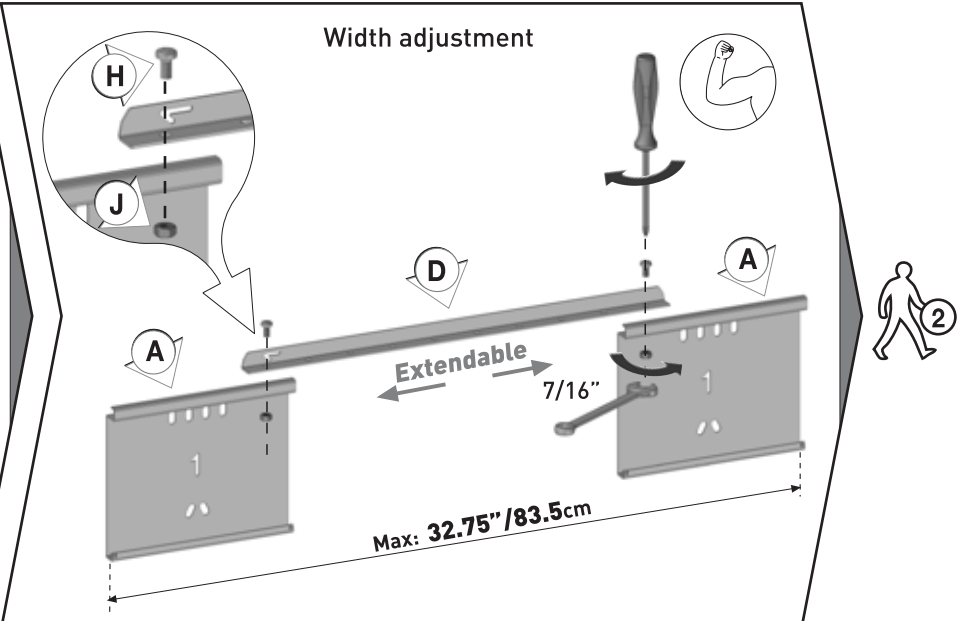

2

Concrete, Solid bricks or Hollow concrete block walls

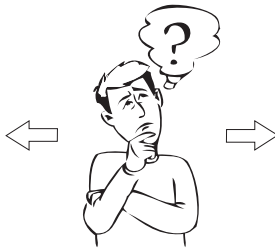
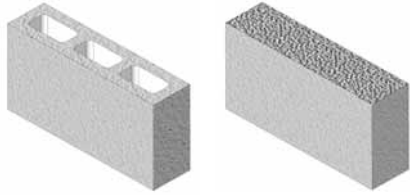

Wood stud wall



2A

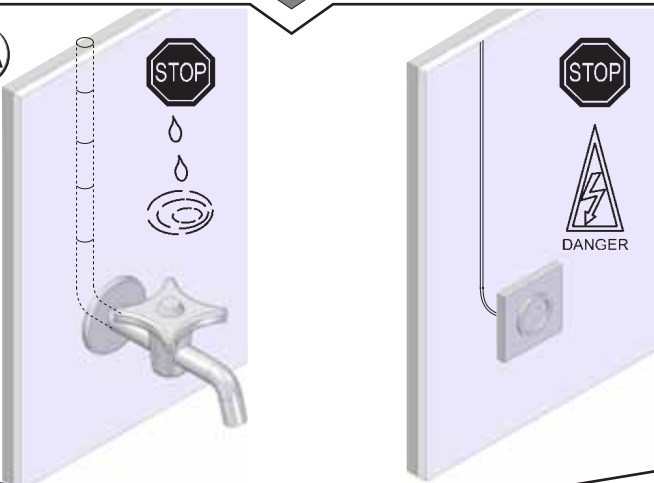

2B

Level & mark

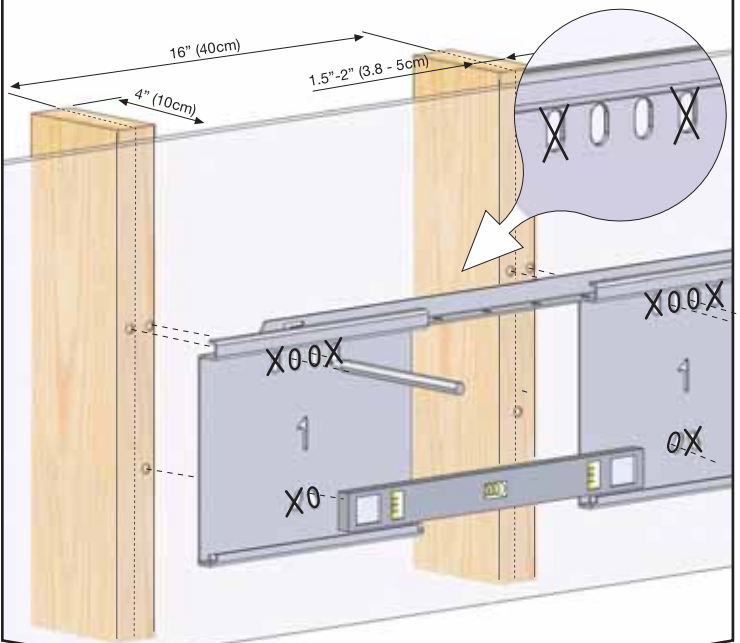

Level & mark

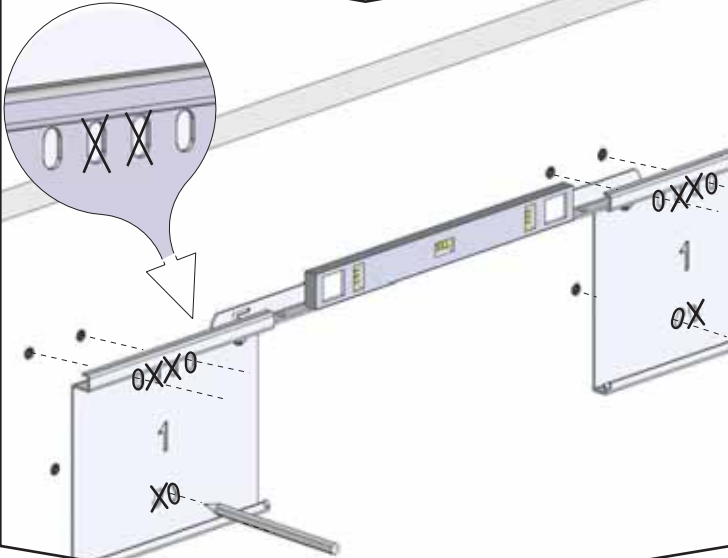

Drill 5/32" (4mm)

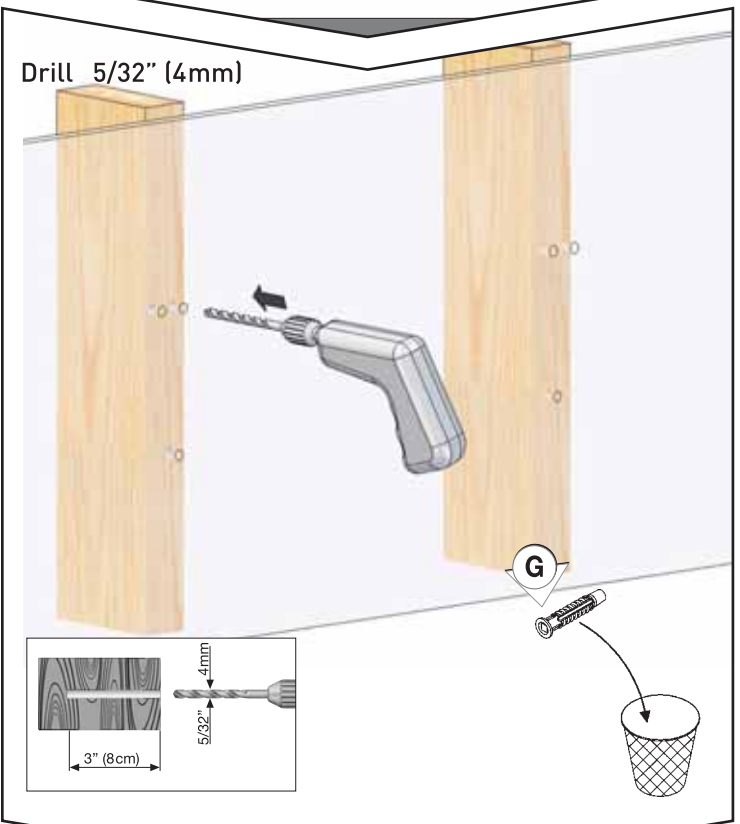

First drill 1/4" (6mm)

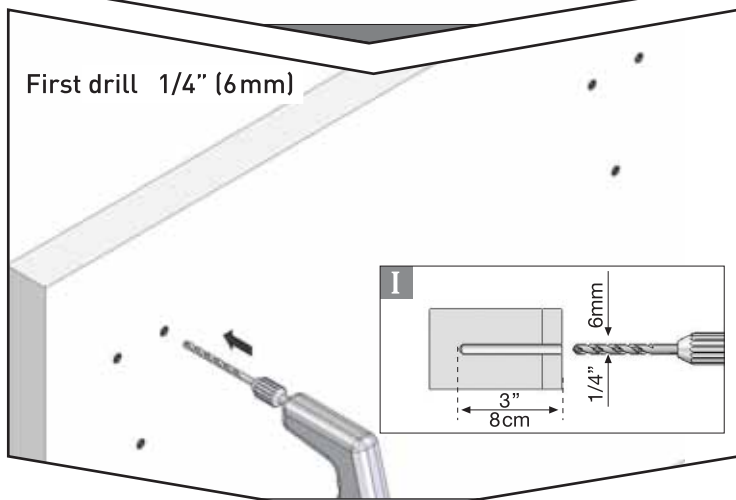

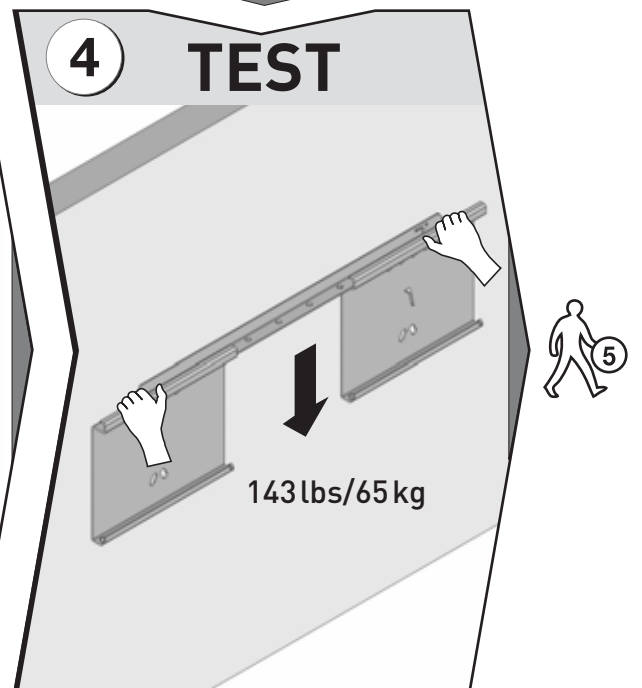
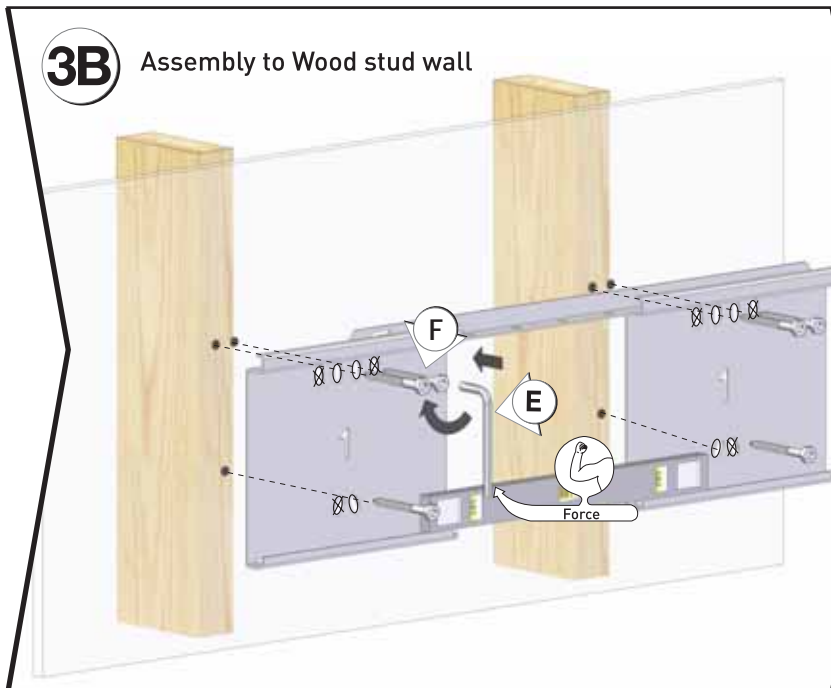
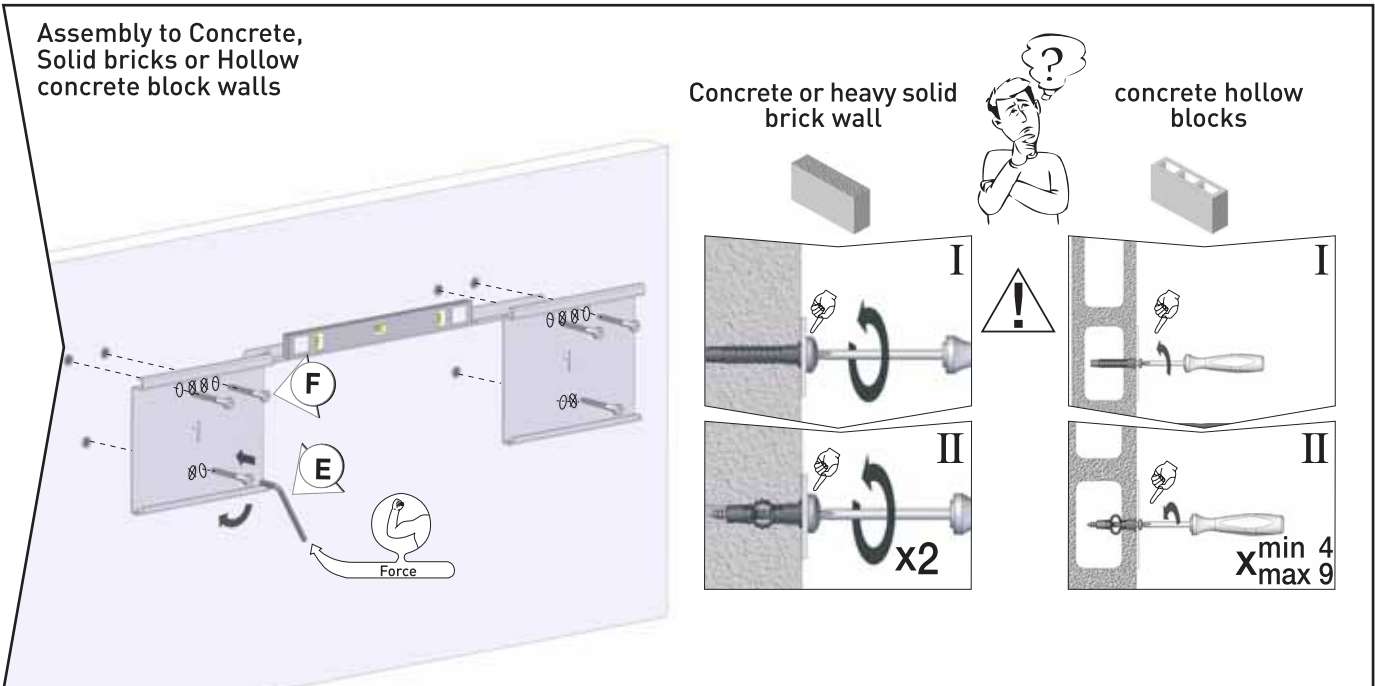
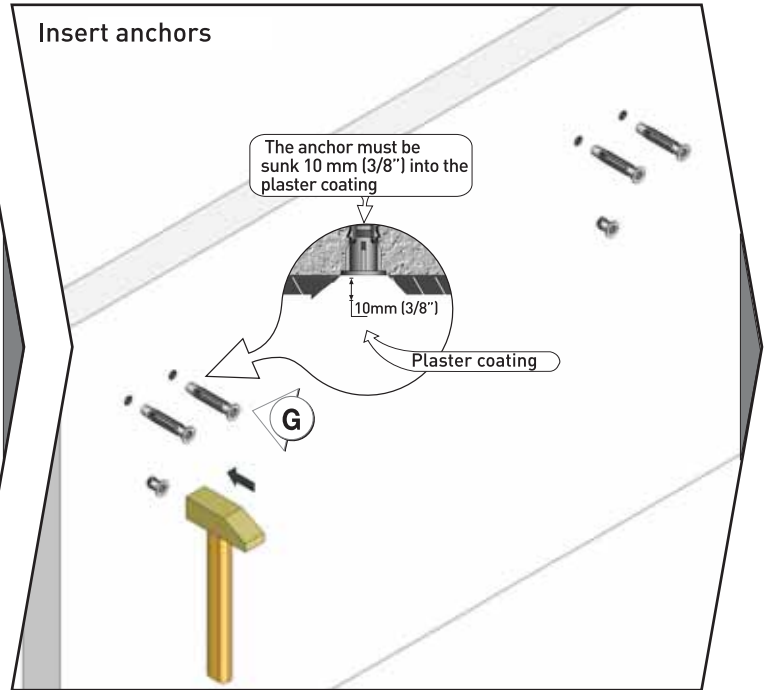
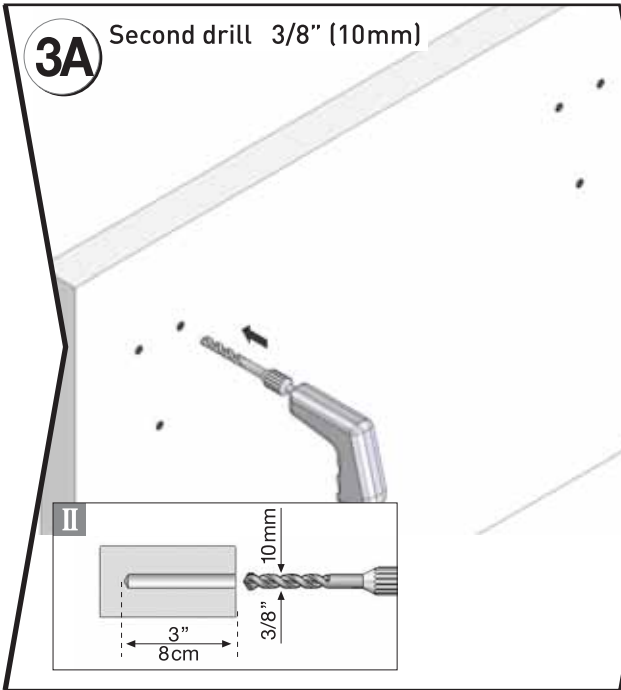

5 Mount screen to the wall

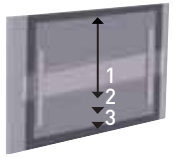

HEIGHT ADJUSTMENT
Choice of 3 height positions for enhanced viewing quality

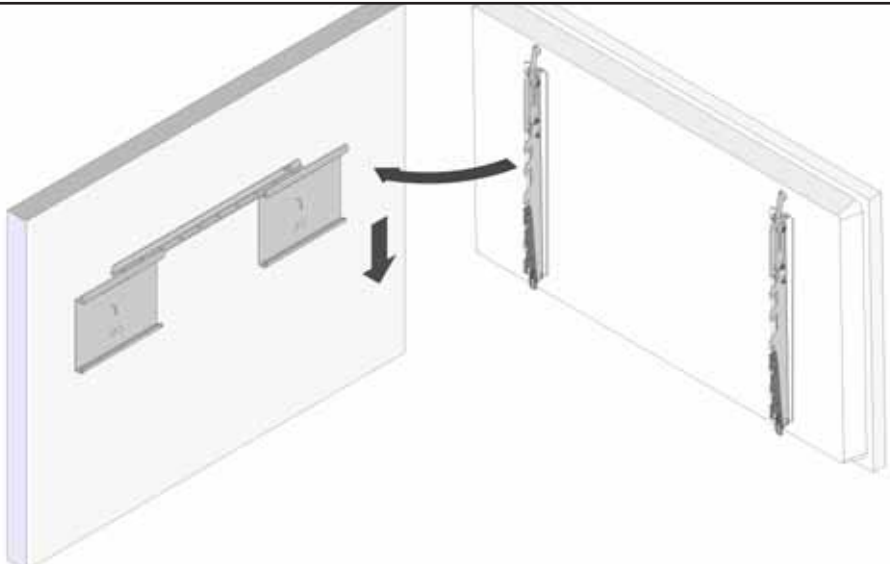

Safety lock hardware assembly

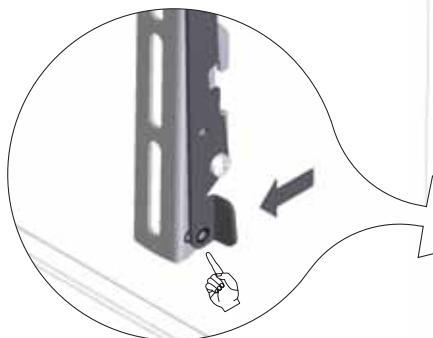

FALL & THEFT PROOF
Secure locking system, preventing theft and accidents

Padlock/safety hardware assembly

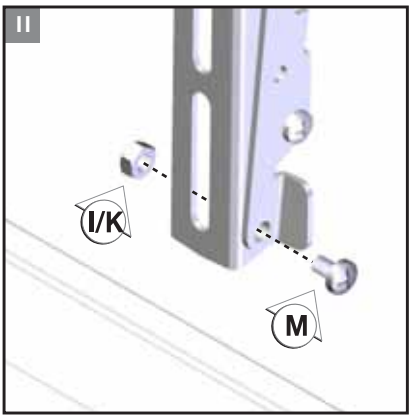
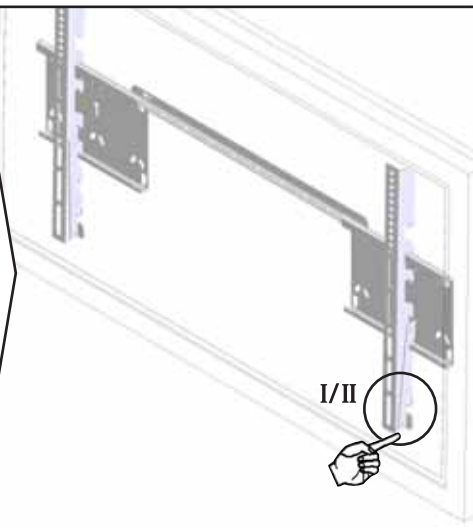

6

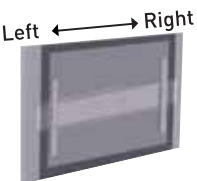

Left & right adjustment
Easy screen positioning during installation, for enhanced viewing quality

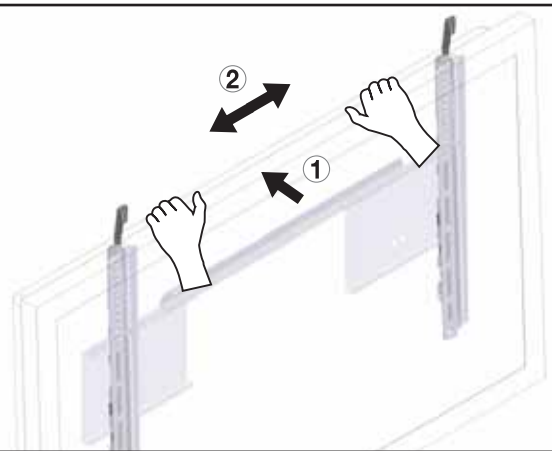

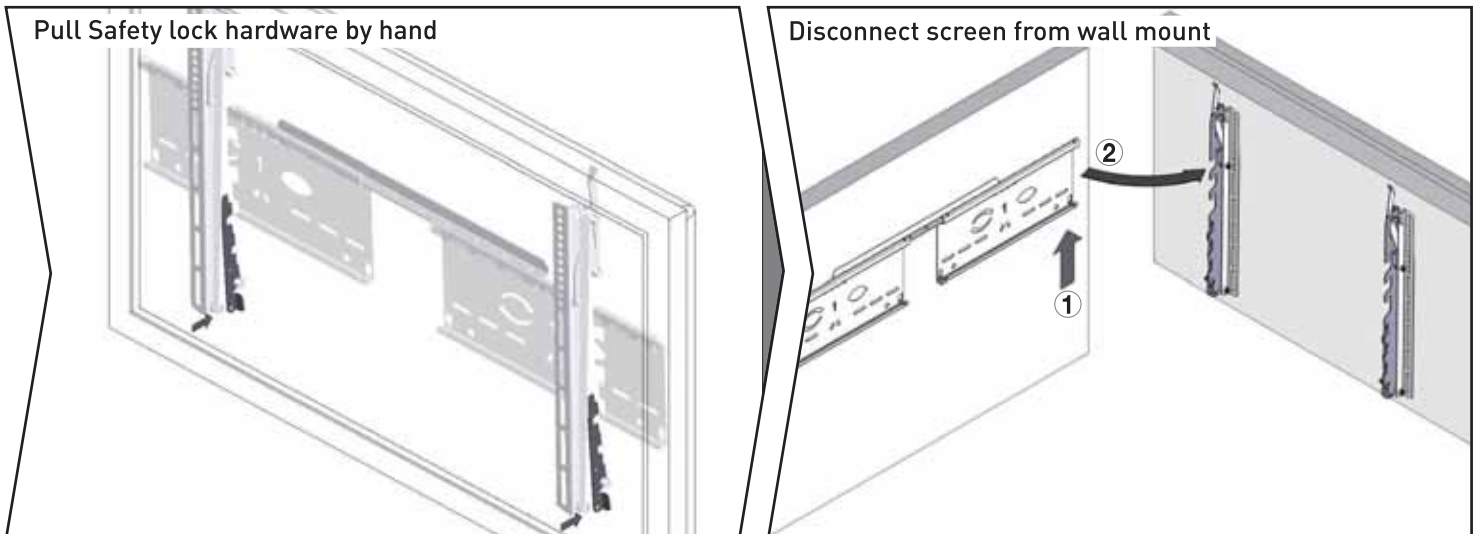
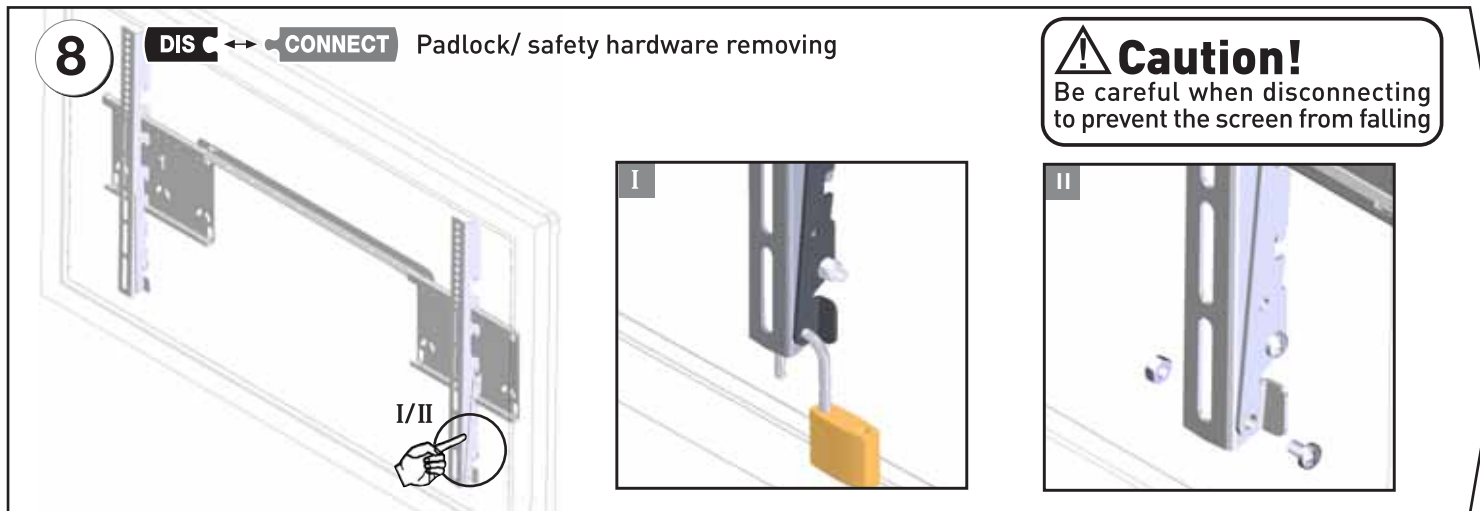
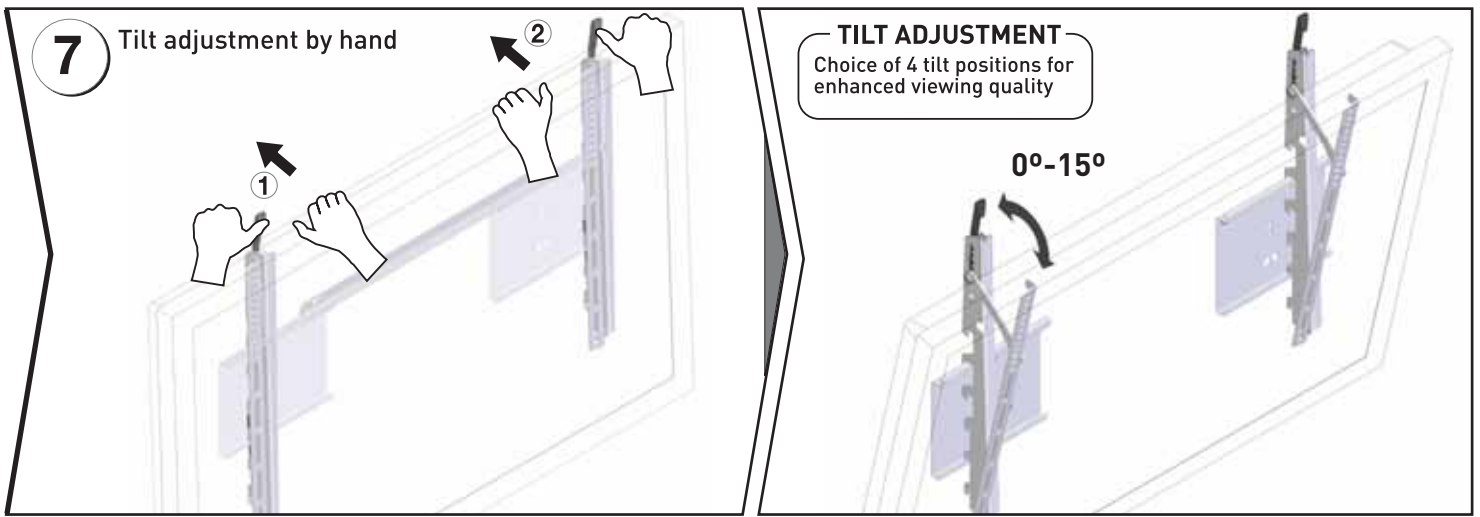

Dear customer, we welcome your comments and suggestions to improve our products, ease of assembly and instructions. Please contact us through our website: www.barkanmounts.com